

Machined | chain guides

(Compact T-profile TGC)

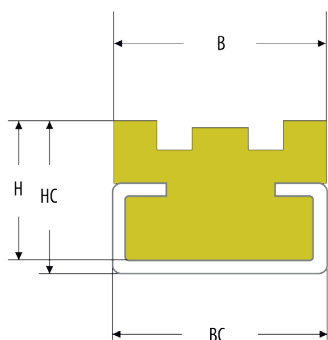

Product Code	C-Steel No.	ISO No.	Chain	Dimensions (mm)				Weight (kg/m)
				B	BC	H	HC	
OPL TGC01	C02	06 B-1	3/8" x 7/32"	20	20	14	17	0.200
OPL TGC02	C02	083-1	1/2" x 3/16"	20	20	14	17	0.772
OPL TGC03	C02	085-1	1/2" x 1/4"	22	20	14	17	0.800
OPL TGC04	C02	08 B-1	1/2" x 5/16"	25	20	16	20	0.297
OPL TGC05	C02	-	5/8" x 1/4"	25	20	16	20	0.890
OPL TGC06	C03	10 B-1	5/8" x 3/8"	28	28	16	20	0.294
OPL TGC07	C03	12 B-1	3/4" x 7/16"	30	28	18	22	0.357
OPL TGC08	C08	16 B-1	1" x 17mm	42	38	25	30	0.681
OPL TGC09	C08	20 B-1	1 1/4" x 3/4"	50	38	30	35	0.901

Machined | chain guides

(Compact T-profile NTG)

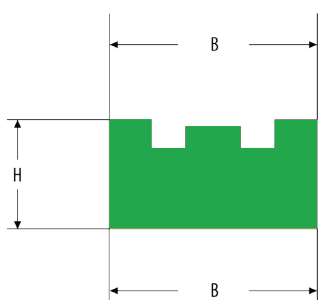

Product Code	ISO No.	Chain	Dimensions (mm)		Weight (kg/m)
			B	H	
OPL NTG01	06 B-1	3/4" x 7/32"	20	10	0.160
OPL NTG02	083-1	1/2" x 3/16"	20	10	0.188
OPL NTG03	08 5-1	1/2" x 1/4"	22	10	0.207
OPL NTG04	08 B-1	1/2" x 5/16"	25	15	0.312
OPL NTG05	-	5/8" x 1/4"	25	15	0.352
OPL NTG06	10 B-1	5/8" x 3/8"	28	15	0.334
OPL NTG07	12 B-1	3/4" x 7/16"	30	20	0.467
OPL NTG08	16 B-1	1" x 17mm	42	25	0.830
OPL NTG09	20 B-1	1 1/4" x 3/4"	50	25	0.933

Machined | chain guides

(CU profile)

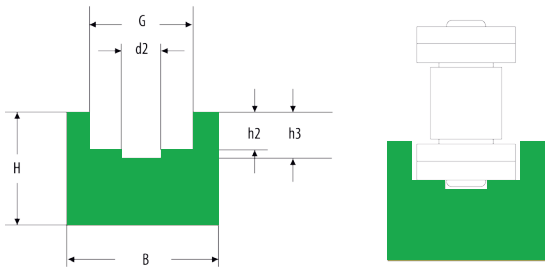

Dimensions (mm)

Product Code	ISO No.	Chain	Dimensions (mm)						Weight (kg/m)
			B	H	h2	h3	d2	G	
OPL U 101	-	3/8" x 5/32"	20	15	2.7	4.0	3.7	9.2	0.262
OPL U 102	06 B-1	3/8" x 7/32"	20	15	2.8	4.2	3.7	9.2	0.262
OPL U 103	083	1/2" x 3/16"	20	15	2.3	3.4	4.0	10.7	0.254
OPL U 104	085	1/2" x 1/4"	20	15	3.2	4.7	4.4	11.7	0.242
OPL U 105	085	1/2" x 1/4"	25	15	3.5	4.7	4.9	12.7	0.307
OPL U 106	08 B-1	1/2" x 5/16"	25	15	3.5	4.8	4.9	12.7	0.307
OPL U 107	-	5/8" x 1/4"	25	15	3.6	5.2	5.5	15.2	0.294
OPL U 108	10 B-1	5/8" x 3/8"	25	15	3.6	5.1	5.5	15.2	0.294
OPL U 109	12 B-1	3/4" x 7/16"	25	20	3.9	5.7	6.2	16.7	0.402
OPL U 110	16 B-1	1" x 17mm	35	25	8.4	9.9	8.9	24.4	0.609

Machined | chain guides

(CU profile)

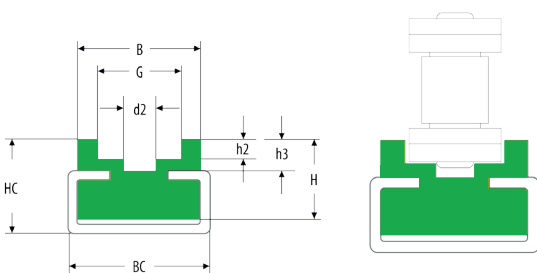

Dimensions (mm)

Product Code	C-Steel No.	ISO No.	Chain	Dimensions (mm)								Weight (kg/m)
				BC	B	H	HC	h2	h3	d2	G	
OPL CU 0101	C01	08 B-1	1/2" x 5/16"	24	20	9	11	3.5	4.8	4.9	12.7	0.112
OPL CU 0203	C03	10 B-1	5/8" x 3/8"	28	23	12	18	3.6	5.1	5.5	15.2	0.315
OPL CU 0303	C03	12 B-1	3/4" x 7/16"	28	23	12	18	3.9	5.7	6.2	16.7	0.165
OPL CU 0408	C08	16 B-1	1" x 17mm	38	32.5	20	30	8.4	9.9	8.9	24.4	0.357
OPL CU 0510	C10	20 B-1	1 1/4" x 3/4"	60	60	25	35	10	11.9	11.0	28.0	0.973
OPL CU 0610	C10	24 B-1	1 1/2" x 1"	60	60	30	40	13	14.9	16.0	35.0	1.340
OPL CU 0710	C10	28 B-1	1 3/4" x 31mm	60	65	40	45	16	18.0	17.0	39.0	1.840
OPL CU 1210	C10	32 B-1	2" x 31mm	60	70	40	45	16	21.7	19.0	44.0	2.040

Machined | chain guides

(T profile for single roller chains)

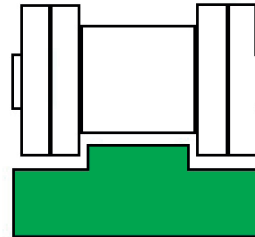
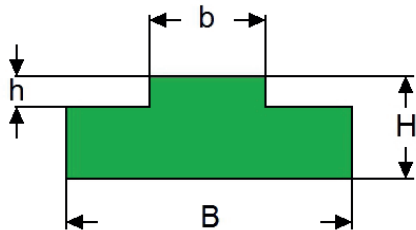

Dimensions (mm)

Product Code	ISO No.	Chain	Dimensions (mm)				Weight (kg/m)
			B	H	b	h	
OPL T 101	-	3/8" x 5/32"	15	10	3.8	1.5	0.125
OPL T 102	06 B-1	3/8" x 7/32"	15	10	5.5	1.5	0.125
OPL T 103	083	1/2" x 3/16"	15	10	4.7	1.6	0.125
OPL T 104	085	1/2" x 1/4"	20	10	6.2	2.1	0.160
OPL T 105	08 B-1	1/2" x 5/16"	20	10	7.5	2.2	0.160
OPL T 106	08 B-1	1/2" x 5/16"	20	15	7.5	2.2	0.254
OPL T 107	08 B-1	1/2" x 5/16"	20	20	7.5	2.2	0.349
OPL T 108	08 B-1	1/2" x 5/16"	20	30	7.5	2.2	0.534
OPL T 109	-	5/8" x 1/4"	20	10	6.3	2.6	0.155
OPL T 110	10 B-1	5/8" x 3/8"	20	10	9.3	2.6	0.155
OPL T 111	10 B-1	5/8" x 3/8"	20	15	9.3	2.6	0.250
OPL T 112	10 B-1	5/8" x 3/8"	20	20	9.3	2.6	0.349
OPL T 113	10 B-1	5/8" x 3/8"	20	30	9.3	2.6	0.541
OPL T 114	12 B-1	3/4" x 7/16"	25	10	11.3	2.4	0.205
OPL T 115	12 B-1	3/4" x 7/16"	25	15	11.3	2.4	0.319
OPL T 116	12 B-1	3/4" x 7/16"	25	20	11.3	2.4	0.434
OPL T 117	12 B-1	3/4" x 7/16"	25	30	11.3	2.4	0.676
OPL T 118	16 B-1	1" x 17mm	40	15	16.5	3.5	0.484
OPL T 119	16 B-1	1" x 17mm	40	20	16.5	3.5	0.674
OPL T 120	16 B-1	1" x 17mm	40	30	16.5	3.5	1.038
OPL T 121	20 B-1	1 1/2" x 3/4"	45	15	19.0	4.2	0.504
OPL T 122	24 B-1	1 1/2" x 1"	50	15	24.7	5.5	0.664
OPL T 123	28 B-1	1 3/4" x 33mm	75	20	30.1	6.8	1.123
OPL T 124	32 B-1	2" x 31mm	80	20	30.1	7.7	1.133

Machined | chain guides

(CT profile for single roller chains)

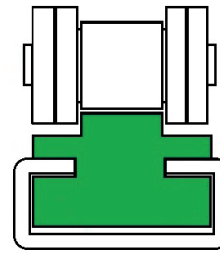
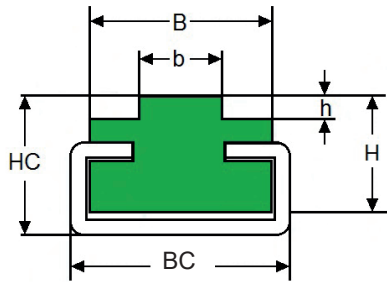

Dimensions (mm)

Product Code	C-Steel No.	ISO No.	Chain	Dimensions (mm)						Weight (kg/m)
				BC	B	b	HC	H	h	
OPL CT 0401	C01	08 B-1	1/2" x 5/16"	24	20	7.5	11	9	2.2	0.135
OPL CT 0202	C02	085	1/2" x 1/4"	20	20	6.2	17	15	2.1	0.217
OPL CT 0402	C02	083	1/2" x 3/16"	20	17	4.7	17	15	1.6	0.205
OPL CT 0502	C02	085	1/2" x 1/4"	20	17	6.2	17	15	2.1	0.197
OPL CT 0602	C02	08 B-1	1/2" x 5/16"	20	17	7.5	17	15	2.2	0.225
OPL CT 0702	C02	-	5/8" x 1/4"	20	17	6.3	17	15	2.6	0.410
OPL CT 0802	C02	10 B-1	5/8" x 3/8"	20	17	9.3	17	15	2.6	0.205
OPL CT 0902	C02	12 B-1	3/4" x 7/16"	20	20	11.3	17	15	2.4	0.222
OPL CT 1003	C03	12 B-1	3/4" x 7/16"	28	23.5	11.3	18	15	2.4	0.274
OPL CT 1103	C03	16 B-1	1" x 17mm	28	23.5	16.5	18	15	3.5	0.282
OPL CT 1203	C03	20 B-1	1 1/4" x 3/4"	28	28	19	18	15	4.3	0.590
OPL CT 1305	C05	24 B-1	1 1/2" x 1"	38	33	24.7	30	25	5.5	0.704
OPL CT 1405	C05	28 B-1	1 3/4" x 31mm	38	38	30.1	30	25	6.8	0.731
OPL CT 1505	C05	32 B-1	2" x 31mm	38	38	30.1	30	25	7.7	0.749
OPL CT 1610	C10	32 B-1	2" x 31mm	60	60	30.1	35	25	7.7	1.240

Machined | chain guides

(T profile for twin roller chains)

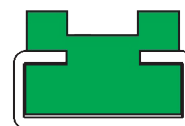
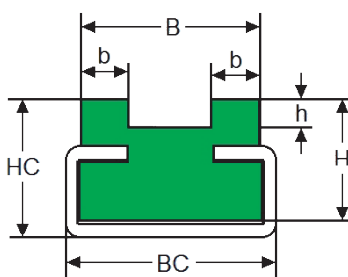

Dimensions (mm)

Product Code	C-Steel No.	ISO No.	Chain	Dimensions (mm)						Weight (kg/m)
				BC	B	b	HC	H	h	
OPL CTD 0102	C02	08 B-2	1/2" x 5/16"	20	21.4	7.5	17	15	2.2	0.237
OPL CTD 0202	C02	10 B-2	5/8" x 3/8"	20	25.7	9.3	17	15	2.6	0.267
OPL CTD 0303	C03	12 B-2	3/4" x 7/16"	28	30.7	11.3	20	15	2.4	0.342
OPL CTD 0405	C05	16 B-2	1" x 17mm	38	48	16.5	27	20	3.5	1.390
OPL CTD 0505	C05	20 B-2	1 1/4" x 3/4"	38	55	19	30	25	4.3	0.948
OPL CTD 0605	C05	24 B-2	1 1/2" x 1"	38	72	24.7	35	30	5.5	1.425

Machined | chain guides

(T profile for twin roller chains)

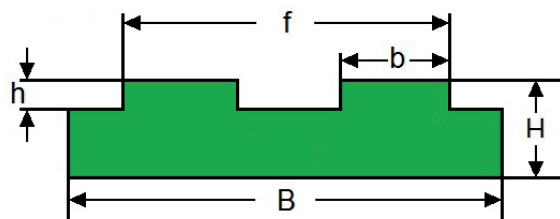

Dimensions (mm)

Product Code	ISO No.	Chain	B	H	b	h	f	Weight (kg/m)
OPL T 201	06 B-2	3/8" x 7/32"	25	10	5.5	1.5	15.7	0.212
OPL T 202	08 B-2	1/2" x 5/16"	35	10	7.5	2.2	21.4	0.287
OPL T 203	08 B-2	1/2" x 5/16"	35	15	7.5	2.2	21.4	0.910
OPL T 204	08 B-2	1/2" x 5/16"	35	20	7.5	2.2	21.4	0.616
OPL T 205	08 B-2	1/2" x 5/16"	35	30	7.5	2.2	21.4	0.945
OPL T 206	10 B-2	5/8" x 3/8"	40	10	9.3	2.6	25.9	0.327
OPL T 207	12 B-2	3/4" x 7/16"	45	10	11.3	2.4	30.8	0.374
OPL T 208	16 B-2	1" x 17mm	65	15	16.5	3.5	48.4	0.629
OPL T 209	20 B-2	1 1/4" x 3/4"	70	15	19	4.2	55.5	0.724
OPL T 210	24 B-2	1 1/2" x 1"	86.6	20	24.7	5.5	73.1	1.248
OPL T 211	28 B-2	1 3/4" x 31mm	110	25	30.1	6.8	89.7	1.921
OPL T 212	32 B-2	2" x 31mm	110	30	30.1	7.7	88.7	2.310

Machined | chain guides

(T profile for triple roller chains)

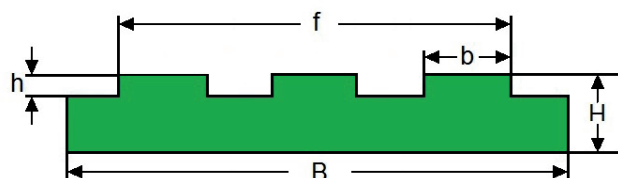

Dimensions (mm)

Product Code	ISO No.	Chain	B	H	b	h	f	Weight (kg/m)
OPL T 301	06 B-3	3/8" x 7/32"	35	10	5.5	1.5	25.9	0.304
OPL T 302	08 B-3	1/2" x 5/16"	45	10	7.5	2.2	35.3	0.374
OPL T 303	08 B-3	1/2" x 5/16"	45	15	7.5	2.2	35.3	0.589
OPL T 304	08 B-3	1/2" x 5/16"	45	20	7.5	2.2	35.3	0.803
OPL T 305	08 B-3	1/2" x 5/16"	45	30	7.5	2.2	35.3	1.228
OPL T 306	10 B-3	5/8" x 3/8"	55	10	9.3	2.6	42.5	0.452
OPL T 307	12 B-3	3/4" x 7/16"	65	10	11.3	2.4	50.3	0.574
OPL T 308	16 B-3	1" x 17mm	95	15	16.5	3.5	80.3	1.168
OPL T 309	20 B-3	1 1/4" x 3/4"	105	15	19	4.2	92	1.300
OPL T 310	24 B-3	1 1/2" x 1"	135	20	24.7	5.5	121.5	2.247
OPL T 311	-	1 3/4" x 31mm	170	25	30.1	6.8	149.3	3.522
OPL T 312	32 B-3	2" x 31mm	170	30	30.1	7.7	149.3	4.262

Machined | chain guides

(Step sliding rail for single roller chains)

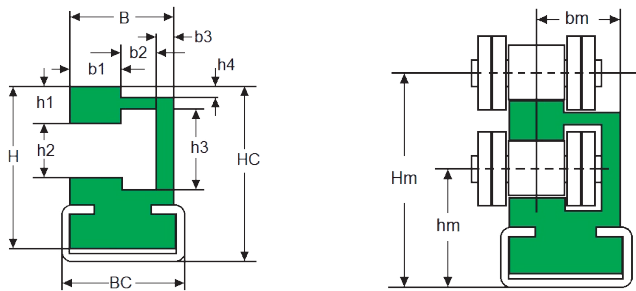

Dimensions (mm)

Product Code	C-Steel No.	ISO No.	Chain	Dimensions (mm)															Weight (kg/m)
				BC	B	H	HC	h1	h2	h3	h4	b1	b2	b3	Hm	hm	bm		
OPL ETC 0102	C02	06 B-1	3/8" x 7/32"	20	20	24	27	6.6	6.6	9.3	1.5	5.2	4.3	10.4	30.2	17.0	14.5	0.329	
OPL ETC 0202	C02	08 B-1	1/2" x 5/16"	20	20	27	30	7.1	8.7	12.8	2.2	7.5	5.0	7.5	33.8	18.0	16.5	0.329	
OPL ETC 0302	C02	10 B-1	5/8" x 3/8"	20	20	33	36	9.7	10.4	15.4	2.6	9.3	5.3	5.5	41.1	21.0	15.5	0.329	
OPL ETC 0403	C03	12 B-1	3/4" x 7/16"	28	24.3	37	41	10.2	12.3	16.9	2.4	11.5	6.0	6.8	46.5	24.0	18.5	0.569	
OPL ETC 0503	C03	16 B-1	1" x 17mm	28	33.5	50	54	11.9	16.1	24.4	3.5	16.5	10.5	6.5	62.0	34.0	25.0	0.926	

Machined | chain guides

(K profile for single roller chains)

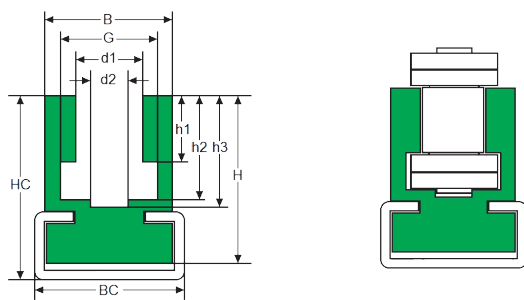

Dimensions (mm)

Product Code	C-Steel No.	ISO No.	Chain	Dimensions (mm)										Weight (kg/m)
				BC	B	H	HC	h1	h2	h3	d2	d1	G	
OPL CK 0102	C02	-	3/8" x 5/32"	20	20	17.5	21	3.8	6.8	9	4	6.6	9.3	0.248
OPL CK 0202	C02	06 B-1	3/8" x 7/32"	20	20	17.5	21	5.6	8.7	9.9	4	6.6	9.3	0.232
OPL CK 0302	C02	083	1/2" x 3/16"	20	20	17.5	21	4.7	7.4	8.3	4	8	10.8	0.232
OPL CK 0403	C03	085	1/2" x 1/4"	28	24	27.5	32	6.3	9.8	11.2	5	8	11.8	0.522
OPL CK 0503	C03	085	1/2" x 1/4"	28	24	27.5	32	6.3	10.2	11.3	5	8.7	12.8	0.522
OPL CK 0603	C03	08 B-1	1/2" x 5/16"	28	24	27.5	32	7.6	11.5	12.7	5	8.7	12.8	0.484
OPL CK 0703	C03	-	5/8" x 1/4"	28	24	27.5	32	6.3	10.3	11.7	6	10.4	15.4	0.483
OPL CK 0803	C03	10 B-1	5/8" x 3/8"	28	24	27.5	32	9.3	13.5	14.8	6	10.4	15.4	0.427
OPL CK 0905	C05	12 B-1	3/4" x 7/16"	38	38	34	43	11.5	15.9	17.5	7.9	12.3	16.9	0.948
OPL CK 1005	C05	16 B-1	1" x 17mm	38	38	40	50	16.5	25.7	27	9	16.1	24.4	0.903

Machined | chain guides

(One piece K profile for single roller chains)

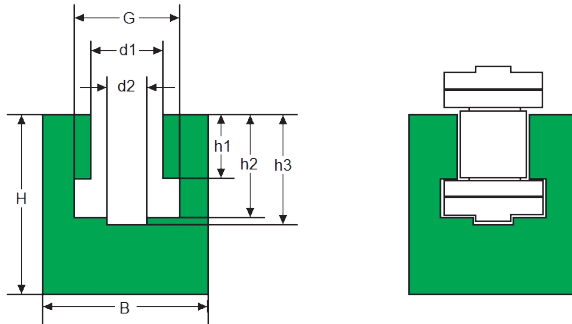

Product Code	ISO No.	Chain	Dimensions (mm)								Weight (kg/m)
			B	H	h1	h2	h3	d2	d1	G	
OPL K 101	-	3/8" x 5/32"	20	25	3.8	6.8	9	4	6.6	9.3	0.419
OPL K 102	06 B-1	3/8" x 7/32"	20	25	5.5	8.7	9.9	4	6.6	9.3	0.404
OPL K 103	083	1/2" x 3/16"	20	25	4.3	7.4	8.3	4	8	10.8	0.397
OPL K 104	085	1/2" x 1/4"	24	30	6.3	9.8	11.2	5	8	11.8	0.586
OPL K 105	085	1/2" x 1/4"	24	30	6.3	10.2	11.3	5	8.7	12.8	0.576
OPL K 106	08 B-1	1/2" x 5/16"	24	30	7.5	11.5	12.7	5	8.7	12.8	0.564
OPL K 107	-	5/8" x 1/4"	30	30	6.3	10.3	11.7	6	10.4	15.4	0.719
OPL K 108	10 B-1	5/8" x 3/8"	30	35	9.3	13.5	14.8	6	10.4	15.4	0.831
OPL K 109	12 B-1	3/4 x 7/16"	40	35	11.3	15.9	17.5	7.9	12.3	16.9	1.103
OPL K 110	-	1" x 17mm	40	45	16.5	25.7	27	9	16.1	24.4	1.270
OPL K 111	20 B-1	1 1/4" x 3/4"	50	50	19	30	32	11	19.3	27.5	1.712
OPL K 112	24 B-1	1 1/2" x 1"	60	60	25.2	38.2	40.1	16	25.7	36.5	2.490
OPL K 113	28 B-1	1 3/4" x 31mm	60	70	30.1	46.9	48.9	17	28.3	41.5	2.473
OPL K 114	32 B-1	2" x 31mm	70	75	30.1	47.3	53	19	29.6	44.5	3.264

Machined | chain guides

(One piece K profile for single roller chains)

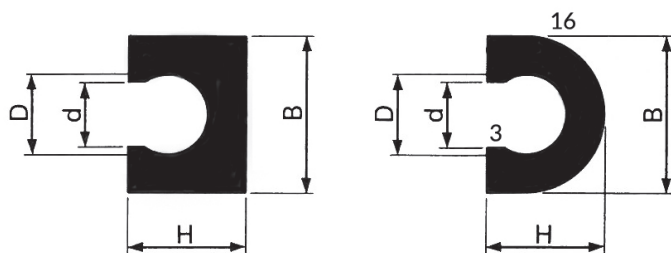

Product Code	Dimensions (mm)			
	D	d	B	H
RB 8	8	7	20	14
RB 10	10	8.5	22	16
RB 12	12	10	24	18

Machined | chain guides

(Compact K profile for single roller chains - type a)

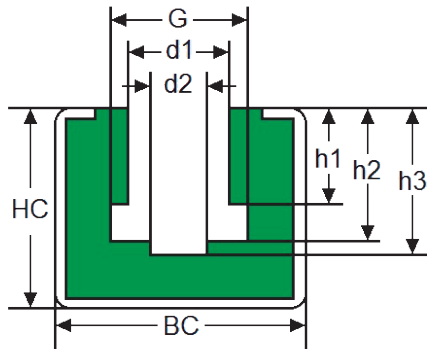

Product Code	C-Steel No.	ISO No.	Chain	Dimensions (mm)									Weight (kg)
				BC	HC	h1	h2	h3	d2	d1	G		
OPL CGK 01	C06	06 B-1	3/8" x 7/32"	30	24	5.6	8.7	9.9	4	6.6	9.3	0.477	
OPL CGK 02	C06	083	1/2" x 3/16"	30	24	4.7	7.4	8.3	4	8	10.8	0.469	
OPL CGK 03	C06	085	1/2" x 1/4"	30	24	6.3	9.8	11.2	5	8	11.8	0.454	
OPL CGK 04	C06	085	1/2" x 1/4"	30	24	6.3	10.2	11.3	5	8.7	12.8	0.442	
OPL CGK 05	C06	08 B-1	1/2" x 5/16"	30	24	7.6	11.5	12.7	5	8.7	12.8	0.437	
OPL CGK 06	C06	-	5/8" x 1/4"	30	24	6.3	10.3	11.7	6	10.4	15.4	0.422	
OPL CGK 07	C06	10 B-1	5/8" x 3/8"	30	24	9.3	13.5	14.8	6	10.4	15.4	0.384	
OPL CGK 08	C06	12 B-1	3/4" x 7/16"	30	24	11.3	15.9	17.5	7	12.3	16.9	0.337	

Machined | chain guides

(Compact K profile for single roller chains - type b)

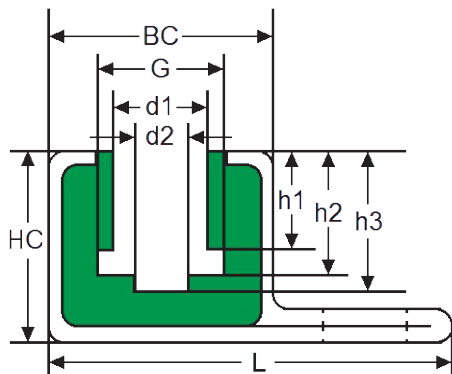

Product Code	C-Steel No.	ISO No.	Chain	Dimensions (mm)									Weight (kg/m)
				BC	HC	L	h1	h2	h3	d2	d1	G	
OPL CGK 01	C15	06 B-1	3/8" x 7/32"	31	25	53	5.6	8.7	9.9	4	6.6	9.3	1.14
OPL CGK 02	C15	083	1/2" x 3/16"	31	25	53	4.7	7.4	8.3	4	8	10.8	1.10
OPL CGK 03	C15	085	1/2" x 1/4"	31	25	53	6.3	9.8	11.2	5	8	11.8	1.10
OPL CGK 04	C15	085	1/2" x 1/4"	31	25	53	6.3	10.2	11.3	5	8.7	12.8	1.10
OPL CGK 05	C15	08 B-1	1/2" x 5/16"	31	25	53	7.6	11.5	12.7	5	8.7	12.8	1.10
OPL CGK 06	C15	-	5/8" x 1/4"	31	25	53	6.3	10.3	11.7	6	10.4	15.4	1.05
OPL CGK 07	C15	10 B-1	5/8" x 3/8"	31	25	53	9.3	13.5	14.8	6	10.4	15.4	1.05
OPL CGK 08	C15	12 B-1	3/4" x 7/16"	31	25	53	11.3	15.9	17.5	7	12.3	16.9	1.05

Machined | chain guides

(Compact T profile TG for single roller chains)

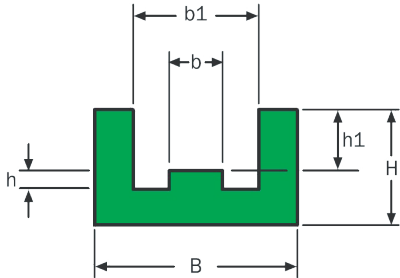

Dimensions (mm)

Product Code	C-Steel No.	Chain	B	H	b	b1	h	h1	Weight (kg/m)
OPL NTG 01	6 B-1	3/8" x 7/32"	20	10	3.8	13	1.5	1.1	0.160
OPL NTG 02	83-1	1/2" x 3/16"	20	10	3.0	12.4	1.6	1.4	0.188
OPL NTG 03	85-1	1/2" x 1/4"	22	10	4.5	15.1	2.2	1.6	0.207
OPL NTG 04	8 B-1	1/2" x 5/16"	25	15	5.7	16.3	2.2	1.6	0.312
OPL NTG 05	-	5/8" x 1/4"	25	15	4.1	16.1	2.6	2.1	0.352
OPL NTG 06	10 B-1	5/8" x 3/8"	28	15	7.4	19.2	2.6	2.1	0.334
OPL NTG 07	12 B-1	3/4" x 7/16"	30	20	9.2	21.8	2.4	2.8	0.467

Machined | chain guides

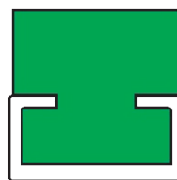
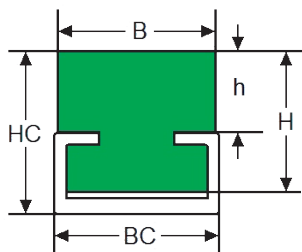

Dimensions (mm)

Product Code	C-Steel No.	BC	B	HC	H	h	Weight (kg/m)
OPL CF 0101	C01	24	20	6	4	0.8	0.075
OPL CF 0201	C02	24	20	11	9	5.8	0.185
OPL CF 0102	C02	20	20	11	6	1.0	0.085
OPL CF 0202	C02	20	20	16	10	6.0	0.165
OPL CF 0302	C02	20	20	14	10	4.0	0.157
OPL CF 0402	C02	20	20	17	15	7.0	0.245
OPL CF 0502	C02	20	20	20	18	10.0	0.302
OPL CF 0603	C03	28	28	15	10	3.0	0.210
OPL CF 0703	C03	28	28	18	15	6.0	0.327
OPL CF 0805	C05	38	38	22	15	4.0	0.506
OPL CF 0905	C05	38	38	25	20	7.0	0.646
OPL CF 1010	C10	60	60	30	20	10.0	1.008

Machined | chain guides

(RR runner for round bets)

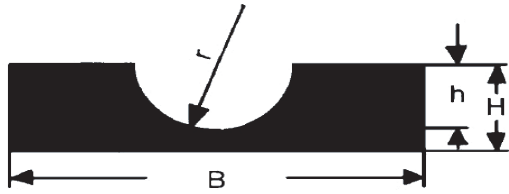

Product Code	Belt \varnothing	Dimensions (mm)				Weight (kg/m)
		B	H	r	h	
OPL RR 05	5	20	10	3	3	0.172
OPL RR 06	6.3	20	10	4	4	0.165
OPL RR 08	8	20	12	5	5	0.187
OPL RR 10	9.5	25	15	6	6	0.297
OPL RR 12	12.5	30	20	7	8	0.482
OPL RR 15	15	35	25	9	10	0.704
OPL RR 18	18	40	25	10	12	0.786

Machined | chain guides

(RRC runner for round belts)

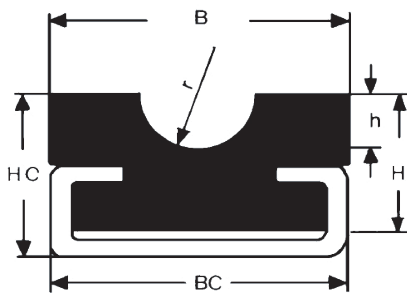

Product Code	Belt \varnothing	C-Steel No.	Dimensions (mm)					Weight (kg/m)	
			BC	B	HC	H	r		h
OPL RRC 0502	5	C02	20	20	15	10	3	3	0.145
OPL RRC 0602	6.3	C02	20	20	18	15	4	4	0.222
OPL RRC 0802	8	C02	20	20	18	15	5	5	0.145
OPL RRC 1003	9.5	C03	28	25	20	15	6	6	0.259
OPL RRC 1203	12.5	C03	28	28	20	15	7	8	0.264
OPL RRC 1505	15	C05	38	33	25	20	9	10	0.469
OPL RRC 1805	18	C05	38	38	25	20	10	12	0.452

Machined | chain guides

(KR runner for V belts)

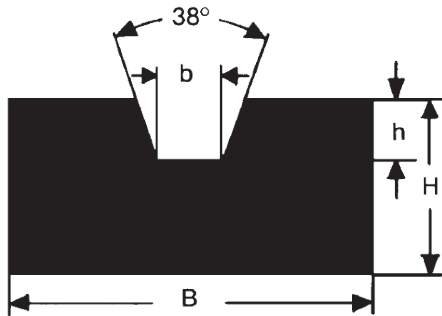

Dimensions (mm)

Product Code	Belt \varnothing	Dimensions (mm)				Weight (kg/m)
		B	H	b	h	
OPL KR 008	8	20	10	6	3.5	0.165
OPL KR 010	10	20	10	7.2	4.5	0.155
OPL KR 013	13	20	12	9.2	6	0.162
OPL KR 017	17	30	15	11.5	8	0.317
OPL KR 020	20	30	20	13.5	9	0.424
OPL KR 022	22	35	20	14.5	10.5	0.477
OPL KR 025	25	40	25	16.5	12	0.701
OPL KR 032	32	50	30	21	16	1.008
OPL KR 040	40	60	35	26	21	1.395

Machined | chain guides

(KRC runner for V belts)

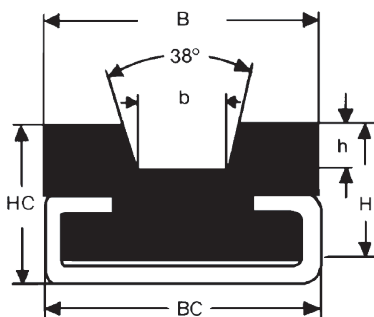

Dimensions (mm)

Product Code	Belt \varnothing	Dimensions (mm)						Weight (kg/m)
		BC	B	HC	H	b	h	
OPL KR 0802	8	20	20	15	10	6	3.5	0.135
OPL KR 1002	10	20	20	18	15	7.2	4.5	0.210
OPL KR 1303	13	28	25	22	18	9.2	6	0.324
OPL KR 1703	17	28	30	24	18	11.5	9	0.317
OPL KR 2003	20	28	30	24	18	13.5	9	0.292
OPL KR 2205	22	38	45	30	25	14.5	10.5	0.611
OPL KR 2505	25	38	40	32	25	16.5	12	0.611
OPL KR 3210	32	60	60	40	35	21.0	16	1.495
OPL KR 4010	40	60	60	40	35	26.0	21	1.200

Machined | chain guides

C profiles - stainless steel (For sliding onto the plastic chain guide profiles)

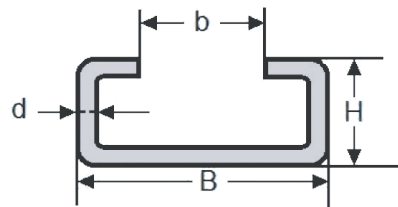
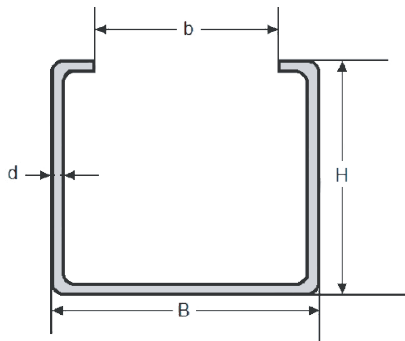

Dimensions (mm)

Galvanized	Stainless	B	H	b	d	Weight (kg/m)
44C01VZ	44C01VA	24	5.2	17.5	1.0	0.280
44C02VZ	44C02VA	20	10	10	1.3	0.430
44C03VZ	44C03VA	28	12	14	2.2	0.950
44C05VZ	44C05VA	38	18	22	1.5	0.980
44C06VZ	44C05VA	30	24	20	1.5	0.940
44C08VZ	44C08VA	38	18	22	2.5	1.430
44C09VZ	44C09VA	45	40	31	2.0	2.160
44C10VZ	44C10VA	60	20	36	2.5	1.200

Machined | chain guides

C profiles - stainless steel (For sliding onto the plastic chain guide profiles)

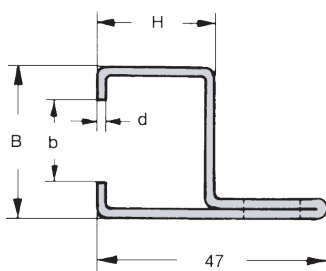

Profile 14

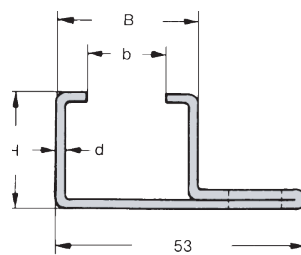

Profile 15

Dimensions (mm)

Galvanized	Stainless	B	H	b	d	Weight (kg/m)
44C 14VZ	44C15VA	31	25	20	2.0	1.200
44C 14VZ OL	4414VAOL	31	25	20	2.0	1.200
44C 15VZ	44C15VA	31	25	20	2.0	1.200
44C 15VZ OL	44C15VAOL	31	25	20	2.0	1.200

OL = Without perforation



Head Office

Oadby Plastics Ltd
68 Scudamore Road
Braunstone Frith Industrial Estate
Leicester
LE3 1UA
0116 232 1010
sales@oadbyplastics.co.uk

Cannock Branch

Unit 9
Longford Road
Prospect Business Park
Cannock
WS11 0LG
01543 462 461
wmsales@oadbyplastics.co.uk

Swindon Branch

Unit 5
Newcombe Drive
Hawksworth Industrial Estate
Swindon
SN2 1DX
01793 529 474
swsales@oadbyplastics.co.uk

Warrington Branch

Unit 16
Chesford Grange
Warrington
WA1 4RQ
01925 851 264
nwsales@oadbyplastics.co.uk

Braintree Branch

Avenue North
Skyline 120 Business Park
Great Notley
Braintree
Essex
CM77 7AA
01376 525 104
sesales@oadbyplastics.co.uk

For further information and specification details please visit our comprehensive website. Due to a policy of continual product development, *Oadby Plastics Ltd* reserves the right to alter any of the specifications given in the publication without prior notice. The specification must be checked with *Oadby Plastics Ltd* prior to manufacture. For this reason no responsibility or liability for accuracy is accepted by *Oadby Plastics Ltd*.

Company registration No. 03542957 | www.oadbyplastics.co.uk



INVESTORS
IN PEOPLE

Certificate Number 8147
ISO 9001, ISO 14001

www.oadbyplastics.co.uk

people and products you can rely on